

FLOS

■ F004H40A071 Anodized Black

Landlord Soft PWM Dimmable Anodized Black

Designed by Piero Lissoni



20° adjustable head for installation on ground poles. Poles to be ordered as separated accessories. 24V remote power supply to be ordered separately. Each head comes with a 2000mm length outgoing cable and a wiring kit.

Are you a professional and your project needs consulting and support?

[BOOK AN APPOINTMENT](#)

Main specifications

Mounting	Ground
Environments	Outdoor wet location
LED type	Power LED
Lamp category	LED
Iicos	No
Power (W)	5
System flux (lm)	269

Physical

Colour	Anodized Black
Trim	No
Orientation	Adjustable
Rotation (°)	359
Transversal tilting (°)	20
Net weight (kg)	0.40
IP internal	65

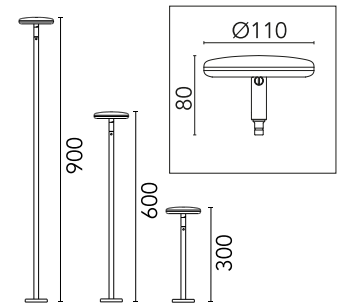

Download

[Mounting instructions](#) ZIP

Photometric Files

[LDT / IES](#) ZIP

Technical Drawings

[2D](#) ZIP

[3D](#) ZIP

[Bim](#) ZIP



Photometric

Lighting type	Direct
Light distribution	Symmetric
CCT (K)	4000
CRI>	80
Beam angle C0-180 (°)	51
Beam angle C90-270 (°)	51

Electrical

Insulation class	III
Frequency (Hz)	50-60
Main voltage (Vac)	24
Driver	Remote excluded
Dimmable	Yes
Dimming type	Non Dimmable, Dimmable 1-10 PWM, Dimmable DALI 1 PWM
Emergency type	No

Ecodesign and Energy Labelling

This product contains a light source of energy efficiency class E

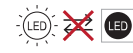

Non-replaceable light source

Notes

Carefully install and maintain the fixtures to avoid damaging the coating. For LED fixtures, most problems are tied to electrical issues related to the insulation, which may cause destructive electrical discharges.

These are frequently caused by:

- power surges from the power network where fixture is connected.
- electrostatic discharge (ESD) from the environment.

We recommend installing a power-surge protection device on the fixture to reduce the intensity of these effects and prevent irreversible damages. The specific device should be chosen based on the electrical characteristics.

Accessories & Power Supply



REQUIRED
Power supply

RF25754

Power supply dual function Vout
24Vdc: 8W/100÷240V Iout
350ma: 6x1W/100÷240V IP20
Class II selv_Non Dimmable



REQUIRED
Power supply

RF25757

Power supply 24V 10W / 110-
240V IP67 Class II selv_Non
Dimmable



REQUIRED
Accessory

F004Z0A0071

Wall base Anodized Black



REQUIRED
Accessory

F004Z0F0071

Pole with base H 900 mm
Anodized Black



REQUIRED
Accessory

F004Z0E0071

Pole with base H 600 mm
Anodized Black



REQUIRED
Accessory

F004Z0D0071

Pole with base H 300 mm
Anodized Black



REQUIRED
Power supply

RF25747

Power supply 24V 10W /110-
240V IP20 Class II selv. Non
Dimmable



REQUIRED
Power supply

RF25748

Power supply dual function Vout
24Vdc: 8W/100÷240V Iout
350ma: 6x1W/100÷240V IP65
Class II selv. Non Dimmable



REQUIRED
Power supply

F990B00A000
CONTROL INTERFACE 24V PWM -
1..10V IP67 CLASS III. VIN 24Vdc
120W (POWER SUPPLY NOT
INCLUDED)



REQUIRED
Power supply

F990B04A000
POWER SUPPLY 24V PWM WITH
1..10V CONTROL INTERFACE
IP67 CLASS II. Vin 120-270Vac
70W



REQUIRED
Power supply

F990B02A000
POWER SUPPLY 24V PWM WITH
1..10V CONTROL INTERFACE
IP67 CLASS II. Vin 120-270Vac
35W



REQUIRED
Power supply

F990B03A000
POWER SUPPLY 24V PWM WITH
DALI CONTROL INTERFACE IP67
CLASS II. Vin 120-270Vac 35W



REQUIRED
Power supply

F990B01A000
CONTROL INTERFACE 24V PWM -
DALI IP67 CLASS III. Vin 24Vdc
120W (POWER SUPPLY NOT
INCLUDED)



REQUIRED
Power supply

F990B05A000
POWER SUPPLY 24V PWM WITH
DALI CONTROL INTERFACE IP67
CLASS II. Vin 120-270Vac 70W



REQUIRED
Power supply

F990B23AZ00
Power supply 24Vdc 35W /120-
270V IP67 Class II selv.



REQUIRED
Power supply

F990B16A000
POWER SUPPLY 24V PWM WITH
PUSH CONTROL INTERFACE IP67
CLASS II. Vin 120-270Vac 35W



REQUIRED
Power supply

F990B17A000

POWER SUPPLY 24V PWM WITH
PUSH CONTROL INTERFACE IP67
CLASS II. Vin 120-270Vac 70W



REQUIRED
Power supply

F990B27A000

Power supply 24Vdc 70W / 220-
240V IP67 Class I selv. Non
Dimmable



REQUIRED
Power supply

F990B28A000

Power supply 24Vdc 50W / 220-
240V IP67 Class I selv. Non
Dimmable



OPTIONAL
Accessory

F990C00A000

2 way terminal block 4 poles IP68
H2O stop. (ø5,5÷12mm cable)



OPTIONAL
Accessory

F990C010000

3/4 way terminal block 4 poles
IP68 H2O stop. (ø5,5÷12mm
cable)



OPTIONAL
Accessory

F004Z060000

Earth stick